

SMILE 1.0
Edelstahl Optik

SMILE 1.0
stainless steel look



GRIFFWERK Schlosskasten geeignet für den Einsatz an Glastüren

GRIFFWERK lock case suitable for use on glass doors

- Vorgerichtet für 8mm Glas
- Verbesserte Drückeraufnahme mit Doppel-Klemmnuss für mehr Stabilität des Griffes
- 3-fache Drückerführung durch Stabilio-Gleitbuchsen aus Hartkunststoff außen am Cover
- ROTA-PERFECT: Zusätzlicher Führungsring für den Vierkantstift, aus wartungsfreiem Slide-Perfect
- Flüsterfalle zur geräuscharmen Nutzung des Schlosses
- Verbindung zum Drücker über passgenaue Führungsbuchsen mit passendem Zierring
- Spezial Softpad Einlage zwischen Glas und Schlosskörper
- Passend für Standard Studio-Bohrungen

- Prepared for 8 mm glass
- Double clip spindle for improved handle attachment
- Three kind of handle leadings by plastic stabilio-sliding bushing on cover side and a special guidance element inside of inner plate
- ROTA-PERFECT: Additional guide ring for square pin, made from maintenance-free Slide-Perfect
- Soft lock for low-noise use of the lock
- Connection to lever via perfect-fitting guide bearings with matching ring
- Special softpad insert between glass and lock body
- Suitable for standard Studio drill holes

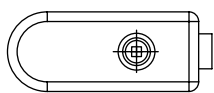
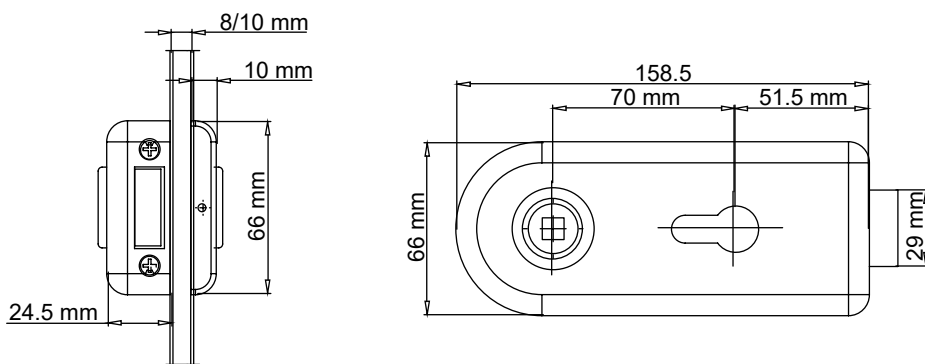

SMILE
Ausführung: UV
SMILE
Option: unlockable

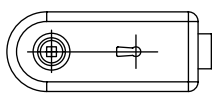

SMILE
Ausführung: BB
SMILE
Option: BB

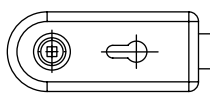

SMILE
Ausführung: PZ
SMILE
Option: Profile Cylinder



2-teiliges Band
SMILE
2-part hinge
SMILE

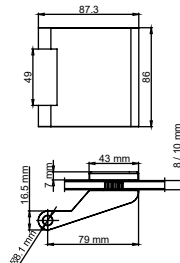
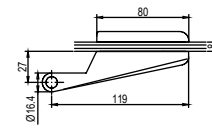

3-teiliges Band
SMILE
3-part hinge
SMILE

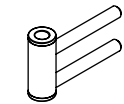

Rahmenteil Holz für 3-teilige Bänder
Frame part wood for 3-part hinges

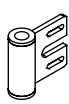

Rahmenteil Stahl für 3-teilige Bänder
Frame part steel for 3-part hinges

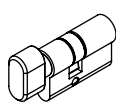

WC-Schliesser
WC lock

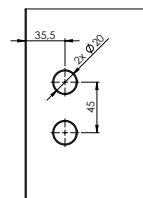

Bohrungen 3-teiliges Band
Bore hinges 3-part hinge

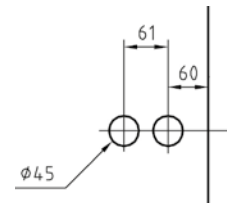

Bohrungen Schlosskasten
Bores glass-door lock